

EURAC®

管道连接件 & 弯管

BENDS & COMPRESSION COUPLINGS

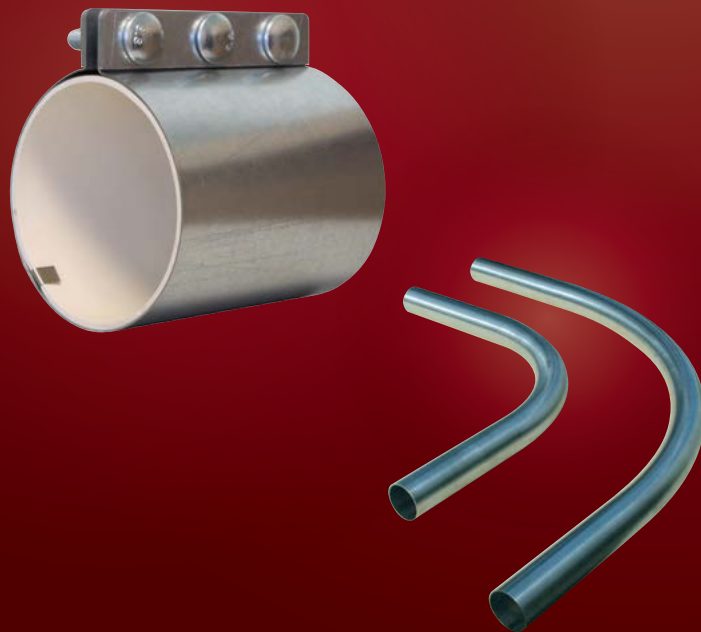

STIF SUZHOU

components for your success

► 中文
► English



斯缇福机械（苏州）有限公司成立于2011年6月，这标志着我们开始履行生产于亚洲并销售于亚洲的发展目标。

斯缇福是专业从事散装物料处理的配件制造商，总部位于法国。自1989年开始，法国STIF一直致力于管道连接件的设计，该产品完美替代了法兰。

通常法兰用于工业粉尘和气力输送系统中的管道连接，法兰需要焊接，这种方法既费时又不经济。与之相反，管道连接件的安装只需要拧紧螺栓便可完成，相比法兰更加简便和经济。

我们生产的EURAC系列管道连接件能用于压力和真空的工作环境，它能承受最高25bar的压力，适用于输送不同密度的物料。

我们承诺在中国，斯缇福机械（苏州）有限公司将同样致力于提供和法国总部一样的产品质量和可靠性。

有关管道连接件更加详细的介绍，请参阅本产品目录。热烈欢迎您随时与我们联系，相信我们能为您提供更好的服务！

STIF Suzhou, our manufacturing facility in China is established in June 2011.

The establishment of STIF Suzhou signifies the venturing of STIF business into Asia & fulfilled our objective to produce in Asia for Asia.

STIF is specialized in the production of components for bulk material handling.

In 1989, STIF designed the range of compression couplings to replace the concept of joining pipes using flanges.

Historically, flanges are used to join pipe network for industrial dusting or pneumatic transfer. This method requires welding which is time consuming & costly.

With coupling concept, pipes are joined easily using bolt & nut on the coupling.

Our EURAC coupling is suitable for pressure as well as vacuum application. It can withstand the pressure of up-to 25 bars & it works well for diluted or dense phases.

STIF has a tight global policy to ensure that all productions location in the world must fulfill the similar product quality and reliability as our HQ, STIF in France.

With this, we would like to introduce you with our full ranges of coupling produced in China @ STIF Suzhou.



气力输送管道连接件 COUPLINGS FOR PNEUMATIC CONVEYING TUBES

L

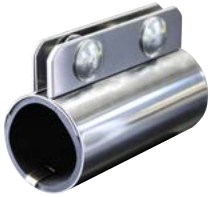

气力输送（比重小的轻型粉粒料）
真空或正压系统
Pneumatic conveying (diluted concentration light particles)
vacuum or pressure systems.

L100
Ø 38,1 <> 114,3

p. 4-5

M



气力输送（比重小的轻型粉粒料）
真空或正压系统
Pneumatic conveying (diluted concentration light particles)
vacuum or pressure systems.

L150
Ø 38,1 <> 114,3

p. 6-7

HL



气力输送（比重大的轻型粉粒料）
真空或正压系统
Pneumatic conveying (diluted and heavy concentration
light particles) vacuum or pressure systems.

L100-L150-L200
Ø 38,1 <> 300

p. 8-9

H



气力输送（比重大的轻型粉粒料）
真空或正压系统
Pneumatic conveying (diluted and heavy concentration
light particles) vacuum or pressure systems.

L150-L200-L250
Ø 38,1 <> 300

p. 10-11

SL



管道连接
Coupling for connecting pipes

L100-L150-L200-L250
Ø 38,1 <> 300

p. 12

Bends

管道接头

PIPE BENDS - CONNECTORS



p. 13-14-15

气力输送（比重小的轻型粉粒料） 真空或正压系统

PNEUMATIC CONVEYING (DILUTED CONCENTRATION LIGHT PARTICLES)
VACUUM OR PRESSURE SYSTEMS



L	100 mm
Ø	38.1<>114.3 mm
螺栓 Bolts	M8
锁紧力 Tightening	20 N.m

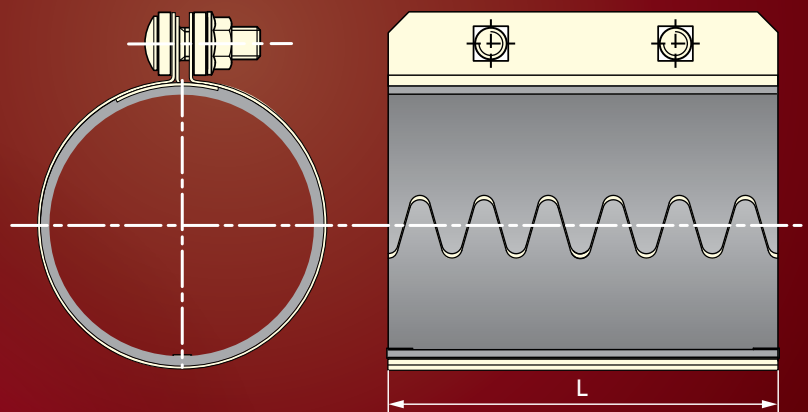

标配技术参数

- 外壳，不锈钢430
- 垫片盖，不锈钢430
- 黑色丁苯橡胶垫圈-30°C/+80°C
- 镀锌螺栓
- 不锈钢304L导电条

SPECIFICATION OF STANDARD COUPLING

- Outside skin in stainless steel 430
- Gasket cover in stainless steel 430
- Black SBR gasket -30°C/+80°C
- Zinc plated bolts
- Stainless steel 304L, conductivity strip

选配

- 不锈钢304
- 普通白色丁腈橡胶垫圈-20°C/+110°C
- 食品级白色丁腈橡胶垫圈-20°C/+110°C
- 硅胶垫圈-60°C/+200°C
- 氟胶垫圈-20°C/+250°C
- 夹固装置（见第5页）
- 用以两端连接不同直径管道的连接件（见第5页）
- 不锈钢304L保护垫圈（见第5页）

OPTIONS

- All stainless steel 304 version
- White NBR gasket Non-FDA -20°C/+110°C
- White NBR gasket FDA -20°C/+110°C
- Silicone VMQ gasket -60°C/+200°C
- Viton FPM gasket -20°C/+250°C
- Coupling with clamp and side bars (see p.5)
- Coupling for two tubes with different diameters (see p.5)
- Conductive protecting ring in stainless steel 304L (see p.5)

EURAC L100最大工作压力曲线表
 MAXIMUM PRESSURE CURVES FOR EURAC L: L100



自由式
 Maximum working pressure
 with free-hanging pipes

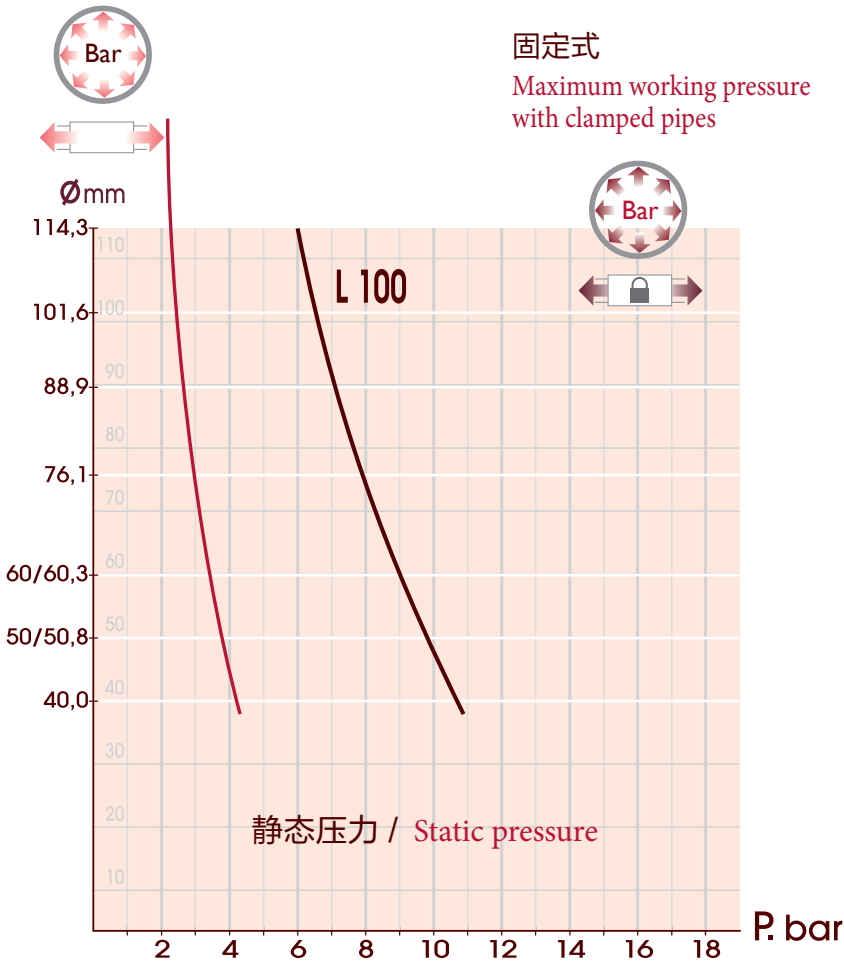

Ø	L100
38,1	有库存 - On stock
40	可订制 - On order
45	可订制 - On order
48,3	有库存 - On stock
50/50,8	有库存 - On stock
54	可订制 - On order
55	可订制 - On order
60/60,3	有库存 - On stock
63,5	有库存 - On stock
65	有库存 - On stock
70	可订制 - On order
75	可订制 - On order
76,1	有库存 - On stock
80	可订制 - On order
82	可订制 - On order
84	可订制 - On order
85	可订制 - On order
88,9	有库存 - On stock
90	可订制 - On order
95	可订制 - On order
100	可订制 - On order
101,6	可订制 - On order
104	可订制 - On order
105	可订制 - On order
108	可订制 - On order
114,3	可订制 - On order

有库存 - On stock
 可订制 - On order

选配 - OPTIONS

• 夹固装置
 Coupling with clamp and side bars

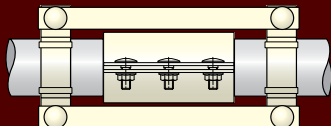

• 不锈钢304L保护垫圈
 Conductive protection ring in stainless steel 304L



• 用以两端连接不同直径管道的连接件
 Coupling for two tubes with different diameters

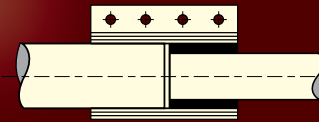

气力输送（比重小的轻型粉粒料） 真空或正压系统

PNEUMATIC CONVEYING (DILUTED CONCENTRATION LIGHT PARTICLES)
VACUUM OR PRESSURE SYSTEMS

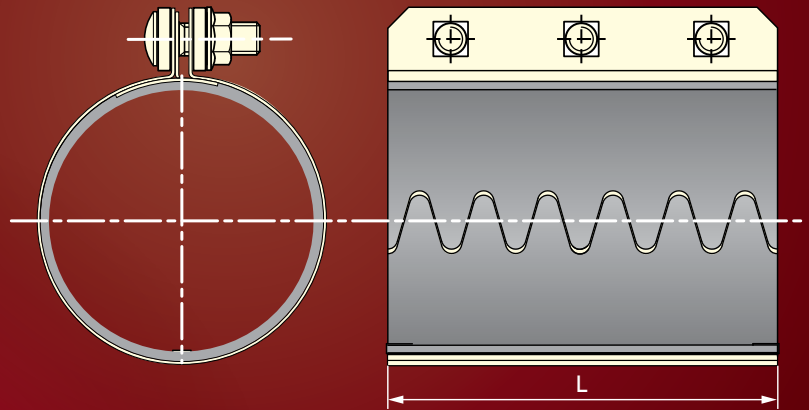

L	150 mm
∅	38.1 <> 114.3 mm
螺栓 Bolts	M8
锁紧力 Tightening	20 N.m

标配技术参数

- 外壳，不锈钢430
- 垫片盖，不锈钢430
- 黑色丁苯橡胶垫圈-30°C/+80°C
- 镀锌螺栓
- 不锈钢304L导电条

SPECIFICATION OF STANDARD COUPLING

- Outside skin in stainless steel 430
- Gasket cover in stainless steel 430
- Black SBR gasket -30°C/+80°C
- Zinc plated bolts
- Stainless steel 304L, conductivity strip

选配

- 不锈钢304
- 普通白色丁腈橡胶垫圈-20°C/+110°C
- 食品级白色丁腈橡胶垫圈-20°C/+110°C
- 硅胶垫圈-60°C/+200°C
- 氟胶垫圈-20°C/+250°C
- 夹固装置（见第7页）
- 用以两端连接不同直径管道的连接件（见第7页）
- 不锈钢304L保护垫圈（见第7页）

OPTIONS

- All stainless steel 304 version
- White NBR gasket Non-FDA -20°C/+110°C
- White NBR gasket FDA -20°C/+110°C
- Silicone VMQ gasket -60°C/+200°C
- Viton FPM gasket -20°C/+250°C
- Coupling with clamp and side bars (see p.7)
- Coupling for tubes with different diameters (see p.7)
- Conductive protecting ring in stainless steel 304L (see p.7)



EURAC M150 最大工作压力曲线表

MAXIMUM PRESSURE CURVES FOR EURAC M: L150



自由式

Maximum working pressure with free-hanging pipes

固定式

Maximum working pressure with clamped pipes

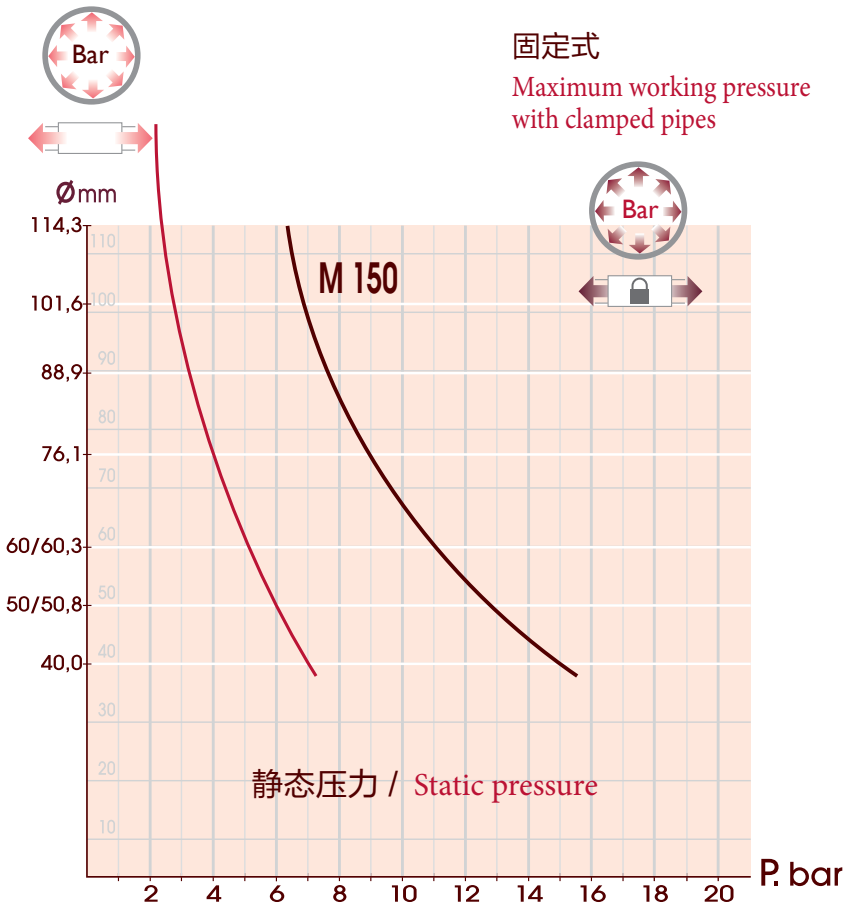

Ø	L150
38,1	
40	
45	
48.3	
50/50,8	
54	
55	
60/60,3	
63,5	
65	
70	
75	
76,1	
80	
82	
84	
85	
88,9	
90	
95	
100	
101,6	
104	
105	
108	
114,3	

有库存 - On stock
 可订制 - On order

选配 - OPTIONS

- 夹固装置

Coupling with clamp and side bars

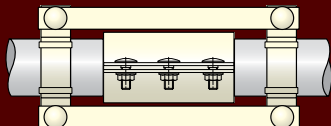

- 不锈钢304L保护垫圈

Conductive protection ring in stainless steel 304L



- 用以两端连接不同直径管道的连接件

Coupling for two tubes with different diameters

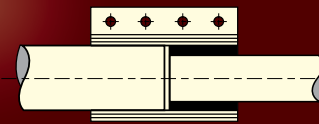

气力输送（比重大的轻型粉粒料）真空或正压系统

PNEUMATIC CONVEYING (DILUTED AND HEAVY CONCENTRATION LIGHT PARTICLES) VACUUM OR PRESSURE SYSTEMS

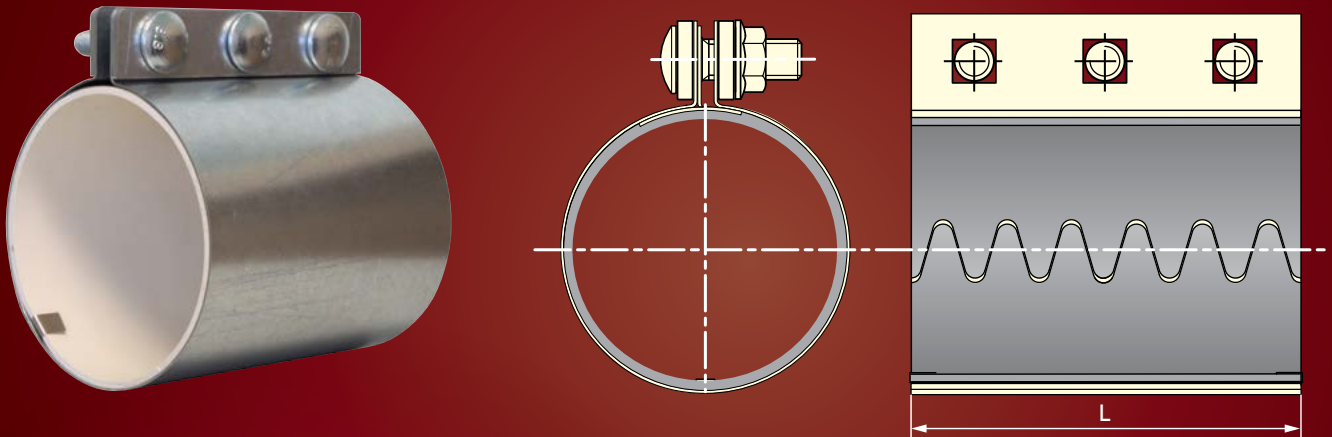

L	100 - 150 - 200 mm
∅	38.1 <> 300 mm

螺栓 Bolts	M10 < ∅ 88.9 M12 ≥ ∅ 88.9
锁紧力 Tightening	M10: 47 N.m - M12: 60 N.m

标配技术参数

- 外壳，镀锌钢
- 垫片盖，镀锌钢
- 普通白色丁腈橡胶垫圈 -20°C/+110°C
- 镀锌螺栓
- 不锈钢304L导电条
- 不锈钢304L保护垫圈

选配

- 不锈钢304
- 食品级白色丁腈橡胶垫圈 -20°C/+110°C
- 黑色丁苯橡胶垫圈 -30°C/+80°C
- 硅胶垫圈 -60°C/+200°C
- 氟胶垫圈 -20°C/+250°C
- 夹固装置（见第9页）
- 用以两端连接不同直径管道的连接件（见第9页）

SPECIFICATION OF STANDARD COUPLING

- Outside skin in galvanised steel
- Gasket cover in galvanised steel
- White NBR gasket Non-FDA -20°C/+110°C
- Zinc plated bolts
- Stainless steel 304L, conductivity strip
- Conductive protection ring in stainless steel 304L

OPTIONS

- All stainless steel 304 version
- White NBR gasket FDA -20°C/+110°C
- Black SBR gasket -30°C/+80°C
- Silicone VMQ gasket -60°C/+200°C
- Viton FPM gasket -20°C/+250°C
- Coupling with clamp and side bars (see p.9)
- Coupling for different diameters (see p.9)



EURAC HL : L100, L 150, L 200最大工作压力曲线表
 MAXIMUM PRESSURE CURVES FOR EURAC HL:
 L100, L150 AND L200

自由式

Maximum working pressure with free-hanging pipes



固定式

Maximum working pressure with clamped pipes

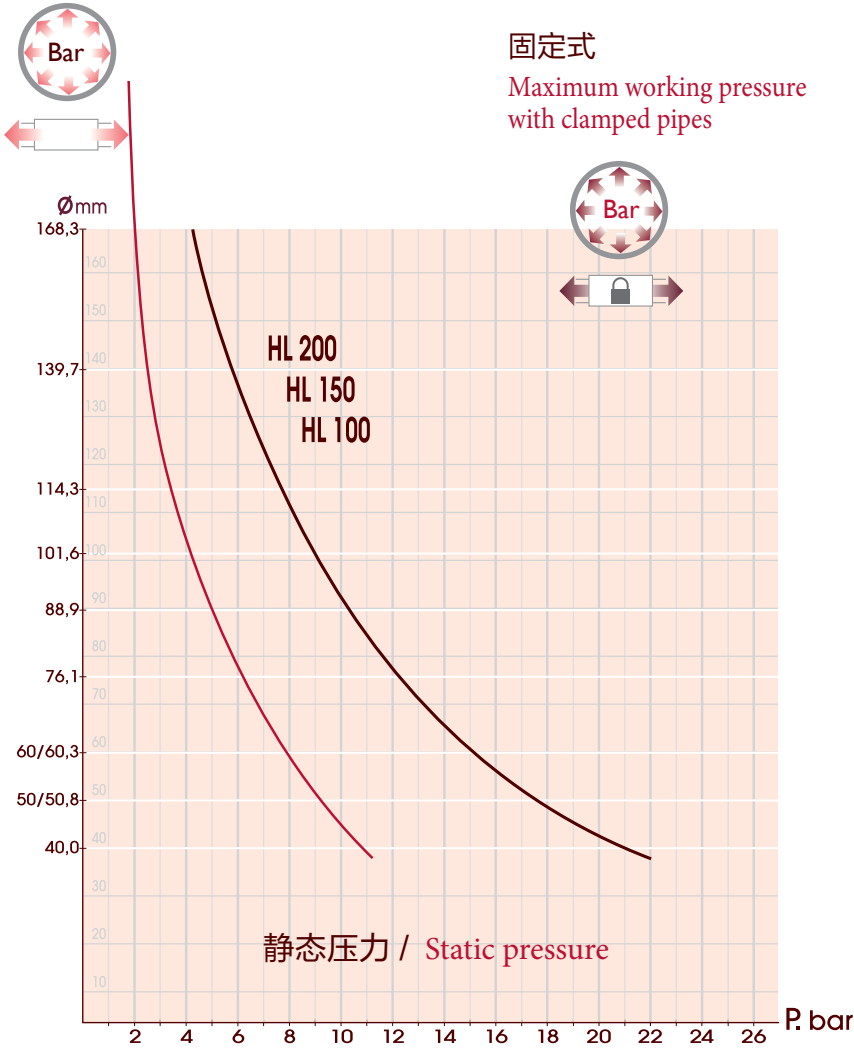

Ø	L 100	L 150	L 200
38,1			
40			
45			
48,3			
50/50,8			
54			
55			
60/60,3			
63,5			
65			
70			
75			
76,1			
80			
82			
84			
85			
88,9			
90			
95			
100			
101,6			
104			
105			
108			
114,3			
125			
127			
129			
133			
139,7			
141,3			
145			
152,4			
154			
155			
159			
168,3			
200			
219,1			
250			
300			

选配 - OPTIONS

- 夹固装置

Coupling with clamp and side bars

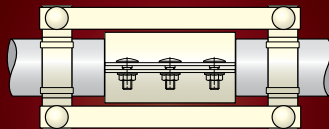

- 用以两端连接不同直径管道的连接件

Coupling for two tubes with different diameters

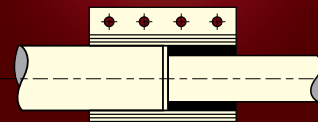

有库存 - On stock
 可订制 - On order



气力输送（比重大的轻型粉粒料）真空或正压系统

PNEUMATIC CONVEYING (DILUTED AND HEAVY CONCENTRATION LIGHT PARTICLES) VACUUM OR PRESSURE SYSTEMS

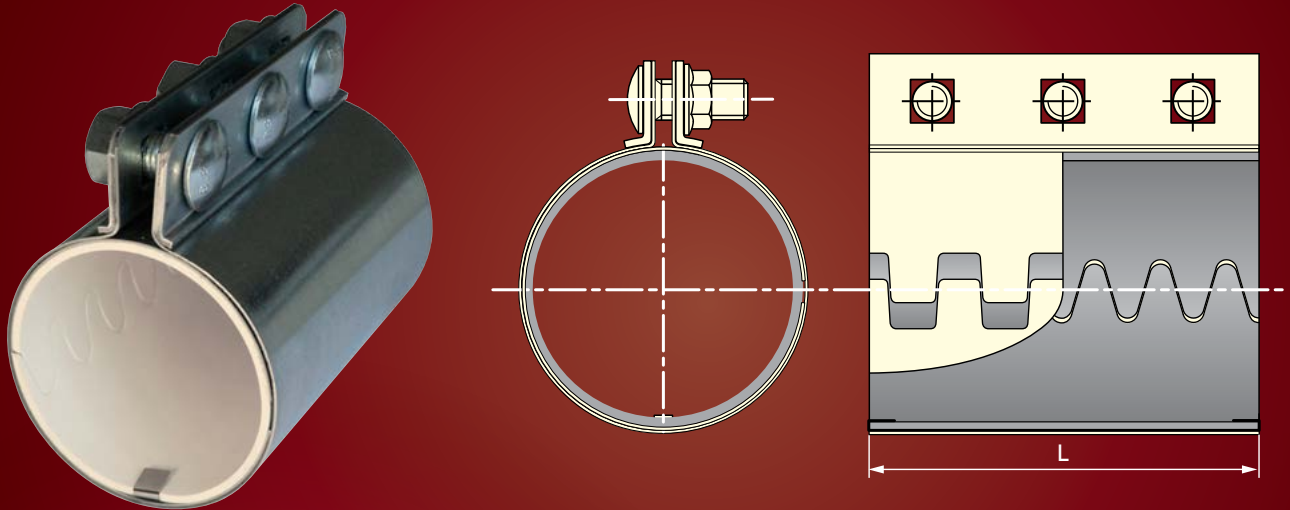

L	150 - 200 - 250 mm
∅	38.1 <> 300 mm

螺栓 Bolts	M12 < ∅ 88.9 M16 ≥ ∅ 88.9
锁紧力 Tightening	M12: 60 N.m - M16: 120 N.m

标配技术参数

- 外壳，镀锌钢
- 内壳，镀锌钢
- 普通白色丁腈橡胶垫圈 -20°C/+110°C
- 镀锌螺栓
- 不锈钢304L导电条
- 不锈钢304L保护垫圈

SPECIFICATION OF STANDARD COUPLING

- Outside skin in galvanised steel
- Inside skin in galvanised steel
- White NBR gasket Non-FDA -20°C/+110°C
- Zinc plated bolts
- Stainless steel 304L, conductivity strip
- Conductive protection ring in stainless steel 304L

选配

- 不锈钢304
- 食品级白色丁腈橡胶垫圈 -20°C/+110°C
- 黑色丁苯橡胶垫圈 -30°C/+80°C
- 硅胶垫圈 -60°C/+200°C
- 氟胶垫圈 -20°C/+250°C
- 夹固装置（见第11页）
- 用以两端连接不同直径管道的连接件（见第11页）

OPTIONS

- All stainless steel 304 version
- White NBR gasket FDA -20°C/+110°C
- Black SBR gasket -30°C/+80°C
- Silicone VMQ gasket -60°C/+200°C
- Viton FPM gasket -20°C/+250°C
- Coupling with clamp and side bars (see p. 11)
- Coupling for different diameters (see p. 11)



EURAC H:L 150, L 200, L 250最大工作压力曲线表

MAXIMUM PRESSURE CURVES FOR EURAC H: L150, L200 AND L250



自由式

Maximum working pressure with free-hanging pipes

固定式

Maximum working pressure with clamped pipes

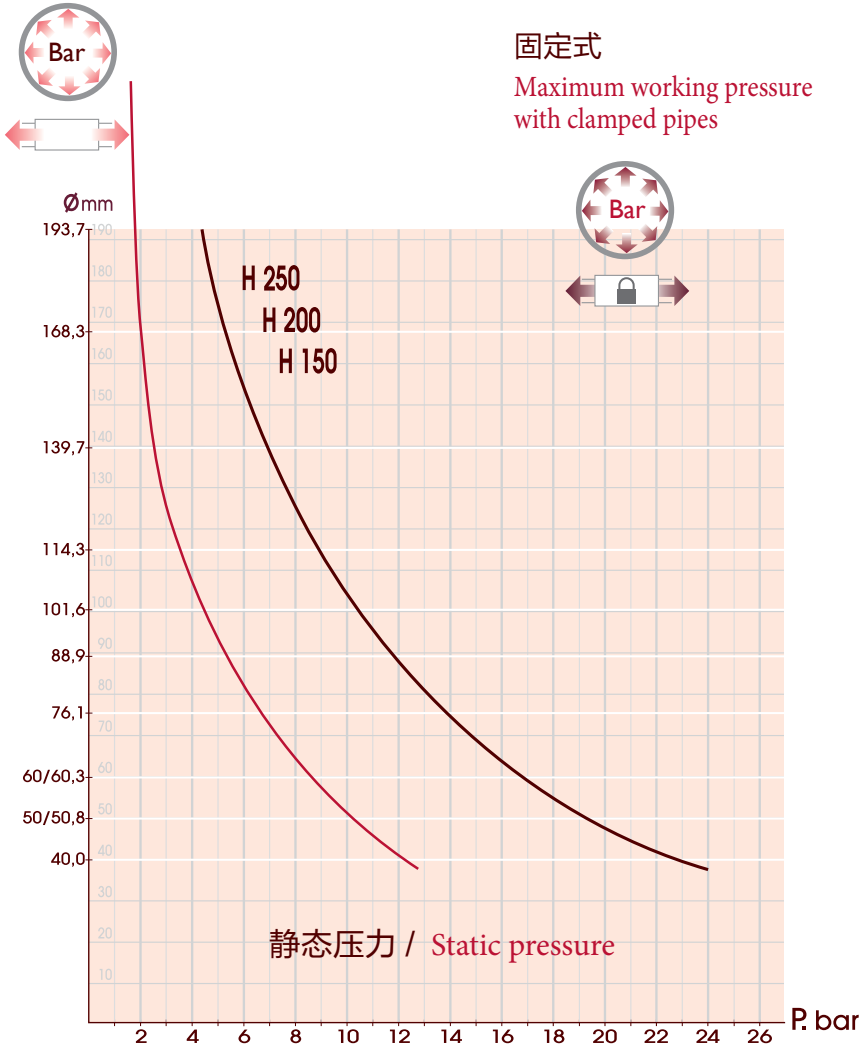

Ø	L 150	L 200	L 250
38,1			
40			
45			
48,3			
50/50,8			
54			
55			
60/60,3			
63,5			
65			
70			
75			
76,1			
80			
82			
84			
85			
88,9			
90			
95			
100			
101,6			
104			
105			
108			
114,3			
125			
127			
129			
133			
139,7			
141,3			
145			
152,4			
154			
155			
159			
168,3			
200			
219,1			
250			
300			

选配 - OPTIONS

- 夹固装置

Coupling with clamp and side bars

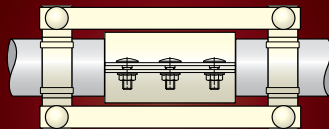

- 用以两端连接不同直径管道的连接件

Coupling for two tubes with different diameters

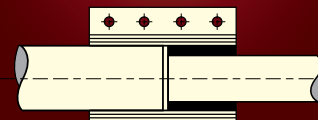

有库存 - On stock

可订制 - On order



管道连接

COUPLING FOR CONNECTING PIPES



L	100 - 150 - 200 - 250 - 300 - 400 - 500 mm
∅	38.1 <> 300 mm

标配技术参数

- 不锈钢430
- 镀锌螺栓

选配

- 不锈钢304
- 镀锌钢
- 内壳

SPECIFICATION OF STANDARD COUPLING

- Stainless steel 430
- Zinc plated bolts

OPTIONS

- All stainless steel 304 version
- All galvanised steel version
- Inside skin

Bends

弯管-不锈钢304 内外抛光 PIPE BENDS - STAINLESS STEEL 304 DEBURRED

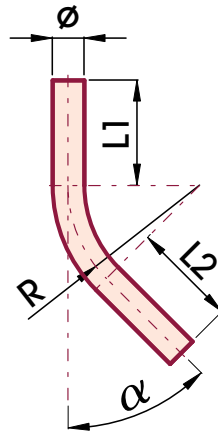
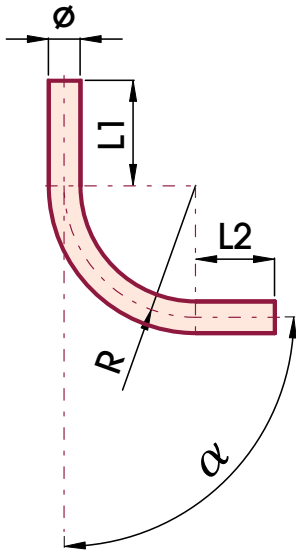

02 BCBI		R		90		150		250		300		400		500			
弯管 Bend	α	45°		90°		45°		90°		45°		90°		45°		90°	
	L1 = L2	100	200	100	200	100	200	100	200	100	200	100	200	100	200	100	200
ϕ 38,1x1,5																	
ϕ 40x1,5																	
ϕ 45x1,5																	
ϕ 48,3x1,5																	
ϕ 50,8x1,5																	
ϕ 60,3x1,5																	
ϕ 63,5x1,5																	
ϕ 70x2																	
ϕ 76,1x2																	
ϕ 85x2																	
ϕ 88,9x2																	
ϕ 101,6x2																	
ϕ 104x2																	
ϕ 108x2																	
ϕ 114,3x2																	

 标准尺寸 – Standard Size

可提供渗氮处理 Nitriding treatment is available



直管-不锈钢304 内外抛光

STRAIGHT PIPES - STAINLESS STEEL 304 DEBURRED

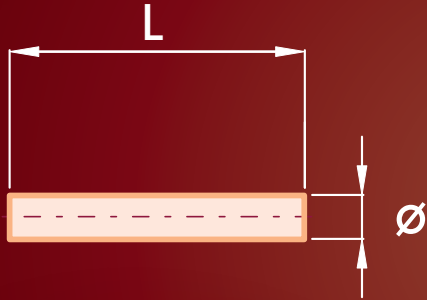

管道 / Pipe	L
Ø	6000
Ø 38,1x1,5	
Ø 40x1,5	
Ø 45x1,5	
Ø 48,3x1,5	
Ø 50,8x1,5	
Ø 60,3x1,5	
Ø 63,5x1,5	
Ø 70x2	
Ø 76,1x2	
Ø 85x2	
Ø 88,9x2	
Ø 101,6x2	
Ø 104x2	
Ø 108x2	
Ø 114,3x2	

 标准尺寸 – Standard Size

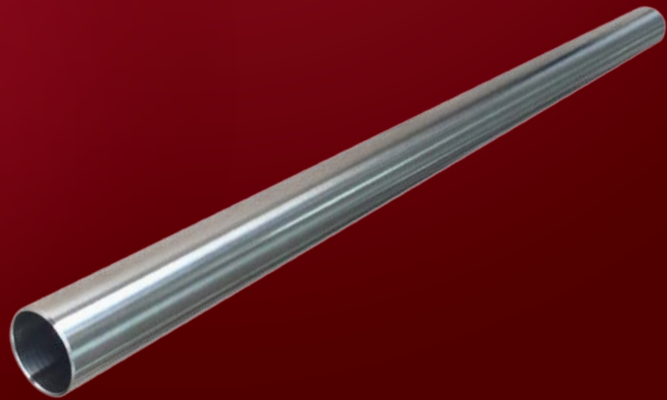

Bends

弯管-高硼硅玻璃 PIPE BENDS - BOROSILICATE GLASS

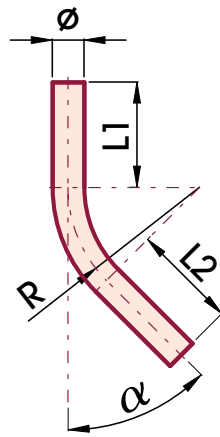
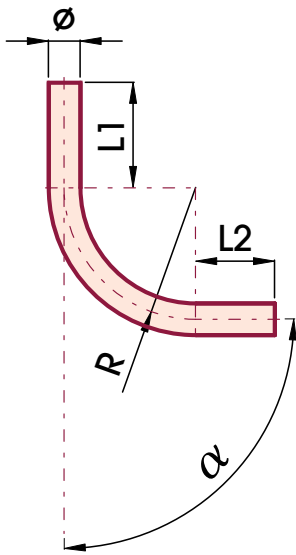

02 BCGI		250				300				400				500			
弯管 Bend	R	45°		90°		45°		90°		45°		90°		45°		90°	
	α	100	200	100	200	100	200	100	200	100	200	100	200	100	200	100	200
	L1 = L2																
\varnothing 45x5																	
\varnothing 47x5																	
\varnothing 51x4																	
\varnothing 56x5																	
\varnothing 58x5																	
\varnothing 66x5																	
\varnothing 70x5																	
\varnothing 76x5																	
\varnothing 85x6																	
\varnothing 89x5																	
\varnothing 95x5																	
\varnothing 108x4																	
\varnothing 110x5																	
\varnothing 113x5																	
\varnothing 120x5																	

*公差Tolerances: 口径Diameter $\leq 70\text{mm}$ $\pm 1,0\text{mm}$, $> 70\text{mm}$ $\pm 2,0\text{mm}$; 厚度Thickness $\pm 1,0\text{mm}$;
管口圆度Roundness $\pm 0,5\text{mm}$; 角度Angle $\pm 1^\circ$





www.stif.cn



EUROPE



STIF

(Siège Social / Head Office)

Usine / Factory

Z.A. de la Lande
49170 Saint-Georges-sur-Loire
FRANCE
Tel.: +33 2 41 72 16 82
Fax: +33 2 41 39 32 12
E mail: sales@stifnet.com
Web: www.stifnet.com

STIF IBERICA

Bureau Commercial

Sales Office

La Selva - 21 Nave 2
Pol. Indus. Les Salines
08880 Cubelles
BARCELONA - ESPAÑA
Tel.: +34 938 950 262
Fax: +34 938 950 298
E mail: ventas@stifiberica.es
Web: www.stifnet.com

STIF EASTERN EUROPE

Bureau Commercial

Sales Office

Lev Landau av. 155-B, off.206
61060 – KHARKIV
UKRAINE
E mail: stifee@stifnet.com
Web: www.stifnet.com

AMERICA

STIF AMERICA

Bureau Commercial

Sales Office

Oficina 4-04 – Centro Empresarial
Mar del Sur
Calle Primera El Carmen – Panamá
Rep. de PANAMÀ
Tel.: +507 393-3787
Fax: +507 393-7467
E mail: stifamerica@stifnet.com
Web: www.stifnet.com

ASIA



STIF SUZHOU

Usine / Factory

Unit 7, N° 2318
East Taihu Road
Wuzhong District, Suzhou City
Jiangsu Province, CHINA
Ph.: +86 512 6656 8968
Fax: +86 512 6656 9128
E mail: sales@stif.cn
Web: www.stif.cn

STIF ASIA

Bureau Commercial

Sales Office

2 Jurong East St 21
#04-28K IMM Building
SINGAPORE 609601
Ph.: +65 6563-2098
Fax: +65 6562-6083
E mail: sales@stif.com.sg
Web: www.stifnet.com

STIF INDONESIA

Bureau Commercial

Sales Office

Jl. Ratna no. 1A
BEKASI – 17412
INDONESIA
Ph.: +62 21 8499 6745
Fax: +62 21 8499 5151
E mail: indo@stif.com.sg
Web: www.stifnet.com

